

A Sash fastener, fitch pattern, lockable

- Key included
- Brass

Finish	Cat. No.
Satin chrome	971.06.022
Polished chrome	971.06.023
Polished brass	971.06.021

Order qty: 1 pc

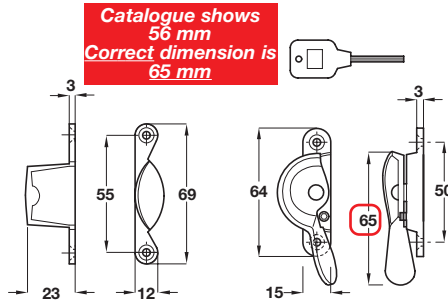

Catalogue shows 56 mm
Correct dimension is 65 mm



Item B. Dimension tolerance text added

B Economy sash fastener

- Zinc alloy
- Please note there is a ± 3 mm tolerance on dimensions

Finish	Cat. No.
Electro brassed	970.04.008
Zinc-plated	970.04.009

Order qty: 1 pc

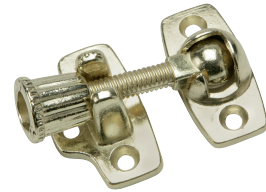
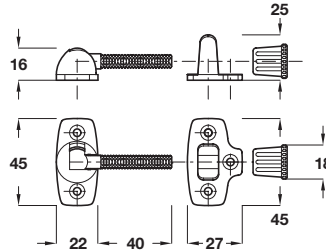

Item C. Dimension tolerance text added

C Economy sash fastener, fitch pattern

- Zinc alloy
- Please note there is a ± 3 mm tolerance on dimensions

Finish	Cat. No.
Bright zinc-plated	970.04.019

Order qty: 1 pc

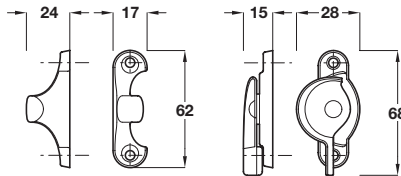

Item D. Dimension amended and tolerance text added

D Sash lift

- Brass
- Please note there is a ± 3 mm tolerance on dimensions

Finish	Dim. A x B x C	Cat. No.
Polished brass	52 x 40 x 34 mm	970.04.028
Satin chrome plated	50 x 40 x 33 mm	970.04.024
Polished chrome plated	51 x 46 x 33 mm	970.04.022

Order qty: 1 pc

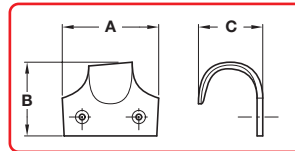

7

Item E. Dimension tolerance text added

E Sash lift, ring

- Brass
- Please note there is a ± 3 mm tolerance on dimensions

Finish	Cat. No.
Polished brass	970.04.038
Satin chrome plated	970.04.034
Polished chrome plated	970.04.032

Order qty: 1 pc



Spec. for polished brass version removed
They are all the same

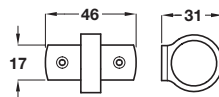

Item F. Dimension tolerance text added

F Pole hook

- To suit \varnothing 25 mm pole (pole not supplied)
- Brass

- Please note there is a ± 3 mm tolerance on dimensions

Finish	Cat. No.
Polished brass	970.04.048
Polished chrome plated	970.04.042

Order qty: 1 pc

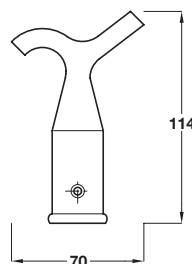

26.02.15/2*