



**Stainless steel effect plinth panels**

Combine the plinth panel set, plinth clip set and the flexible plinth connector to create a stylish yet simple plinth system.

**Stainless steel effect plinth panel set**

- Set consists of 3 m length plinth panel and finishing strip for 150 mm high plinth
- Plinth clips must be ordered separately
- Anodised aluminium

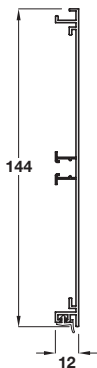

Finish	Cat. No.
Satin stainless steel effect	713.35.401

Order qty: 1 pc

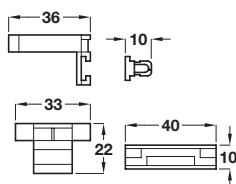

**Plinth clip set**

- Set consists of 12 clips and brackets, for use with 3 m plinth panel
- Clip clips onto standard plinth foot (not included) and bracket slots into plinth groove

Finish	Cat. No.
Black plastic	637.45.930

Order qty: 1 set

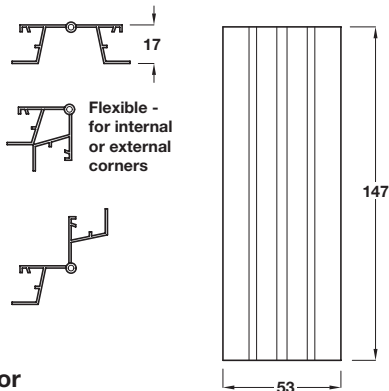

**Flexible plinth connector**

- For use with plinth panels **713.35.401** and **713.28.515**
- Anodised aluminium

Finish	Cat. No.
Satin stainless steel effect	● <b>713.28.950</b>

Order qty: 1 pc

**Discontinued**  
For 713.28.950 - Offer alt. 713.28-0020

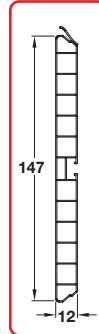
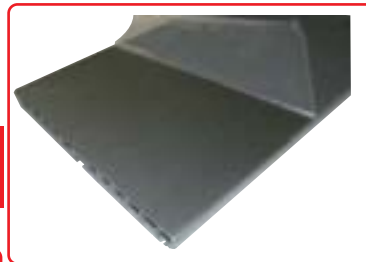

**Catalogue shows 150 mm**  
**Correct height**  
**is 147 mm**

**Plinth panel**

- 147 mm high
- 3000 mm lengths
- Stainless steel coated PVC

**Photo and illustration amended**  
**due to specification change**

Finish	Cat. No.
Satin brushed	713.28.515

Order qty: 1 pc

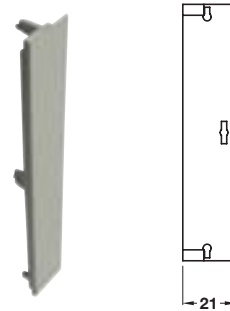

**End cap**

- 150 mm high
  - For use with PVC plinth panel
- 713.28.515**
- PVC

Finish	Cat. No.
Light grey	713.28.520

Order qty: 1 pc

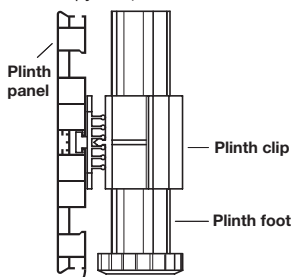

**Plinth clip**

- For use with PVC plinth panel item **713.28.515**
- Can also be used with aluminium plinth panel item **713.35.401**
- Plastic

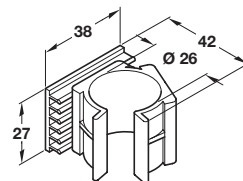

Finish	Cat. No.
Black	713.28.540

Order qty: 1 set (order in multiples of 12 sets)

**Catalogue shows... '1 pc'**  
**Correct order qty is:**  
**1 set (order in multiples of 12 sets)**

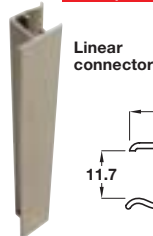

**90 degree**  
**or end**  
**connector**

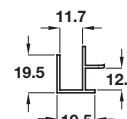

**Plinth connector**

- For use with aluminium plinth panel **713.35.401**
- 146 mm high for plinth 150 mm
- Champagne coloured anodised aluminium

Item	Linear	90 degree / end connector
Cat. No.	781.34.994	781.34.995

Order qty: 1 pair

TCH-HF 2010, HUK. Dimensional data not binding. We reserve the right to alter specifications without notice.