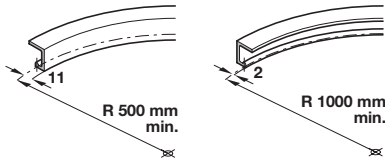

**Application:**

Vertically adjustable sliding door fitting for interior doors. For either straight sliding or curved applications and where visible trolleys are required as a feature

**Range:**

- Max. door weight **70 kg**
- Min. door thickness **25 mm**
- Max. door height **2.3 m**

**Minimum bend radius details for curved top track**

**A Top track, open sided profile**

- With screw-holes, soffit fixing
- Silver anodised aluminium

Length	2.5 m	3.5 m
Cat. No.	942.17.250	942.17.350

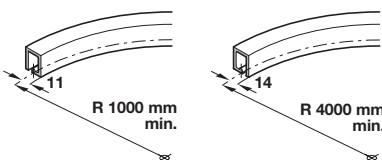
Order qty: 1 pc (2.5 or 3.5 m length)

**Minimum bend radius details for curved top track**

**B Top track, captive profile**

- With screw-holes
- Two top tracks are mounted side by side for double or multiple doors
- Curved track applications: Open sided track A may be curved on site for large radii, 10 m and above. Can be easily bent by installer. For tighter radii, precision radiused curves can be manufactured in Switzerland to order. With such applications trolley hanger E together with top mounting plate F must be used. Details of top track curving shown above
- Silver anodised aluminium

Length	2.5 m	3.5 m
Cat. No.	407.63.255	407.63.353

Order qty: 1 pc (2.5 or 3.5 m length)

**C Track stopper**

- For adjustable mounting in top track
- Secured with allen key
- Bright aluminium

	Cat. No.
Track stopper	942.14.041

Order qty: 1 pc (2 pcs required per panel)

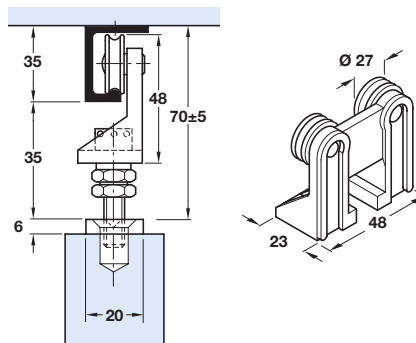
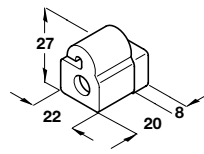
**D Trolley, for top fixing plate**

- For straight or curved sliding doors
- Ball-bearing mounted, plastic tyred rollers
- Galvanized steel
- Order top fixing plate F separately

	Cat. No.
Trolley	942.17.012

Order qty: 1 pc (2 pcs required per panel)

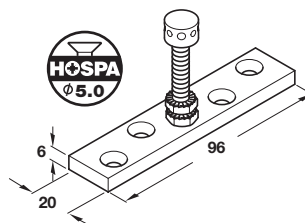
**E Top fixing plate**

- For attachment to top edge of door
- With M8 pendant bolt, nuts and locking washers

	Cat. No.
Top fixing plate	942.14.022

Order qty: 1 pc (2 pcs required per panel)

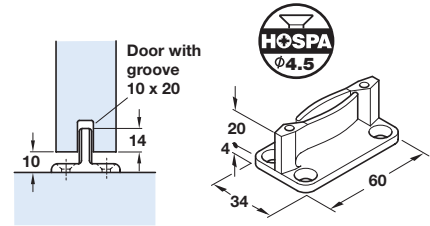
**F Guide - clear threshold**

- Screw-mounted to floor
- Brown plastic

	Cat. No.
Guide	940.40.031

Order qty: 1 pc (1 pc required per panel)

**G Rubber buffer**

- Screw fixing
- Black rubber

	Cat. No.
Rubber buffer	407.01.930

Order qty: 1 pc

**H Guide**

- Steel with nylon pilot

	Cat. No.
Guide	407.49.111

Order qty: 1 pc

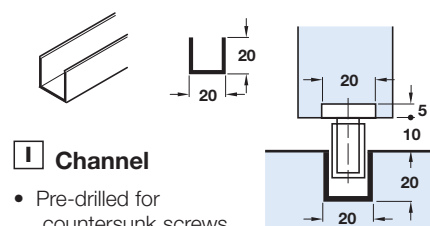
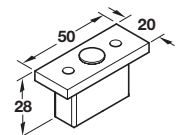
**I Channel**

- Pre-drilled for countersunk screws
- Anodised aluminium

Length	2.5 m	3.5 m
Cat. No.	940.41.250	940.41.350

Order qty: 1 pc (1 pc = 2.5 or 3.5 m length)