

# Fittings for Straight Sliding Timber/Metal Interior Doors

## Straightaway 100

- **Normally for interior straight sliding timber or metal doors weighing up to 100 kg**
- **Application:** Top hung either side or soffit fixed, straight sliding doors for domestic, school, hospital use, etc.
- **Range:** Maximum door weight **100 kg**  
Maximum door height **2.5 m**  
Door thickness **20-50 mm**
- **Door construction -** Adequate top rail required to provide secure fixing of hanger. Minimum door thickness 30 mm when using floor guide channel.

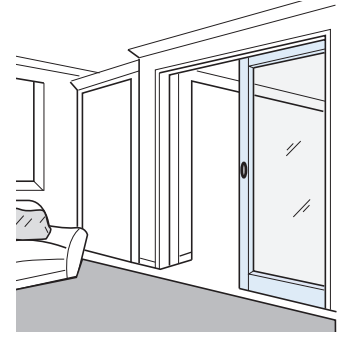
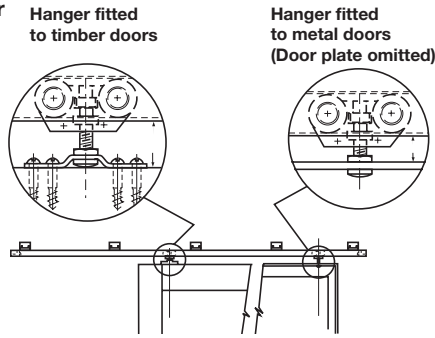

**A Top track, 30 x 30 mm**  
Soffit fixing or side fixing with bracket **D**. Galvanized steel

Length	2.1 m	3.0 m
Cat. No.	941.06.921	941.06.930

Order qty: 1 pc (2.1 or 3.0 m length)

**B Radius track curve**  
600 mm radius. Galvanized steel

Cat. No.	941.06.906
----------	------------

Order qty: 1 pc (0.6 m length)

**C Top track, 30 x 30 mm**  
Pre-drilled for soffit fixing or side fixing with bracket **D**. Stainless steel

Length	3.0 m
Cat. No.	941.06.931

Order qty: 1 pc (3.0 m length)

**D Side fixing bracket**  
Extruded aluminium. For use with galvanized steel and stainless steel tracks only - top tracks **A** and **C**

Cat. No.	941.06.080
----------	------------

Order qty: 1 pc (1 pc required every 500 mm)

**E Closed end piece**  
To convert **D** to closed end bracket and prevent lateral movement of track. Galvanized steel

Cat. No.	941.06.081
----------	------------

Order qty: 1 pair (1 pair required per length of track)

**F Top track, 30 x 30 mm**  
Alternative to track **A** and **C**. Undrilled. Anodised aluminium

Length	2.1 m	3.0 m
Cat. No.	941.06.821	941.06.830

Order qty: 1 pc (2.1 or 3.0 m length)

**G Trolley hanger**  
Door plate omitted when hanger is fitted to metal doors. Nylon body with four nylon wheels

Cat. No.	941.06.012
----------	------------

Order qty: 1 pair (1 pair required per panel)

**H Height adjustment spanner**  
Required to adjust the position of the trolley hangers for final door alignment. Galvanized steel

Cat. No.	941.06.090
----------	------------

Order qty: 1 pc (1 pc required per application)

**I Track stopper**  
Medium duty. For use with track **A**, **C** and **F**. Galvanized steel with nylon clamp.  
**Important:** Spacer nib must be filed off when used with aluminium track **F**

Cat. No.	941.06.040
----------	------------

Order qty: 1 pair (1 pair required per panel)

**J Rubber buffer, screw fixing. Black rubber**

Cat. No.	407.01.930
----------	------------

Order qty: 1 pc

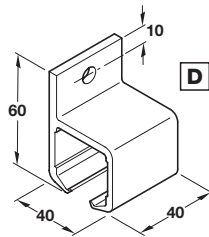
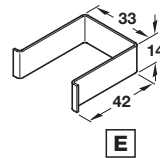
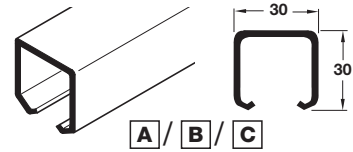
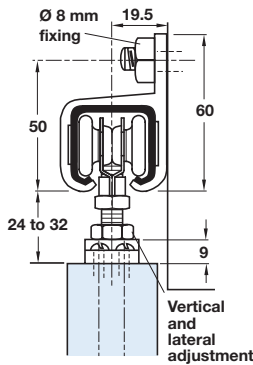

Not for use with side fixing bracket **D**

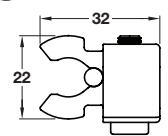
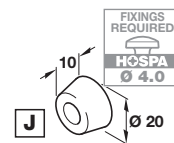
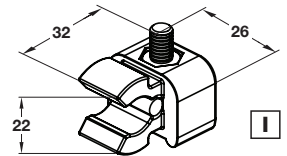
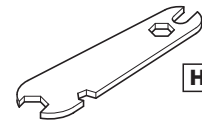
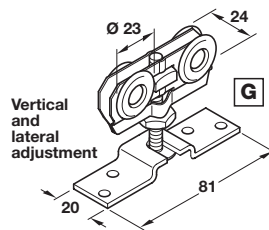
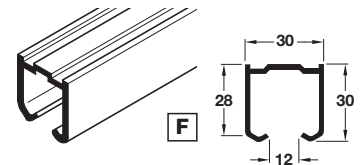

**Medium duty clear threshold**  
Maximum door width normally 1.5 m

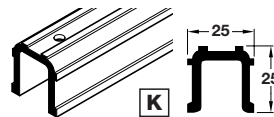
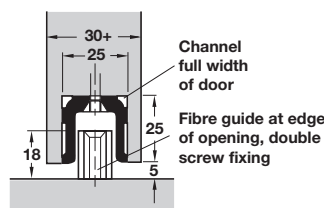

**K Bottom channel insert 25 x 25 mm**  
Pre-drilled for countersunk screws. Bright aluminium

Length	2.1 m	3.0 m
Cat. No.	942.51.721	942.51.730

Order qty: 1 pc (2.1 or 3.0 m length)

**L Clear threshold bottom guide, opaque fibre/polypropylene**

Cat. No.	407.51.059
----------	------------

Order qty: 1 pc (1 pc required per panel)

