

A5-81 New product

150cm "Opera" Dual cavity Cooker
with Gas hob and Electric griddle
Energy rating AA

MAIN OVEN



- 8 functions
- Oven capacity: gross - 90 litres, net - 77 litres
- Digital analogic display
- Air cooling system
- Closed door grilling
- Triple glazed removable door
- 4 cooking levels, metal side supports
- Easy clean enamel interior

AUXILIARY OVEN



- 8 functions
- Oven capacity: gross - 70 litres, net - 54 litres
- Digital analogic display
- Triple glazed removable door
- Air cooling system
- Closed door grilling
- 4 cooking levels, metal side supports
- Easy clean enamel interior
- Special pizza cooking function

HOB



- 7 Burners + griddle
- Front left: Ultra rapid burner 4.20kW
- Rear left: 1.80kW
- Front centre: 1.05kW
- Rear centre: 3.00kW
- Front right: 1.05kW
- Rear right fish burner: 1.90kW
- Right: Ultra rapid burner 5.0kW
- Electric griddle: 1.60kW
- Heavy duty cast iron pan stands
- Automatic electronic ignition
- Safety valves
- Adaptable for LPG

STANDARD ACCESSORIES:

Main oven:
2 x Baking trays
2 x Chrome shelves
Stay clean liners



Auxiliary oven:
1 x Extra deep tray (40mm deep)
1 x Grill mesh
1 x Chrome shelf
Stay clean liners
Pizza Accessories: Refractory stone + cover + shovel

Nominal power: 7.70kW

- Supply can vary depending on usage, please consult a qualified electrician for ampere requirement

Functions

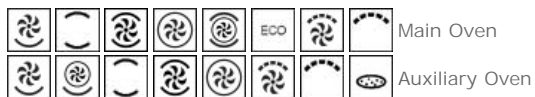

Options

- **KIT1A5-5** - St/steel splash back for A5-8 and A5-81
- **PRTX** - Pizza stone with handles
- **PALPZ** - Folding Pizza Shovel
- **GC120** - Cast Iron Ribbed Griddle
- **GO120** - Cast Iron Open Griddle for Barbecue
- **TPKX** - Teppanyaki Grill Plate

Smeg (UK) Ltd
The Magna Building, Wyndyke Furlong, Abingdon
OX14 1DZ
Tel. +44 (0)844 557 9907
Fax +44 (0)844 557 9337



Main Oven

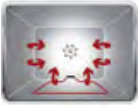

FAN WITH LOWER ELEMENT/ CIRCOGAS:

In electric ovens this combination completes cooking more quickly of foods that are ready on the surface, but that require more cooking inside, without further browning. In gas ovens the fan distributes the heat quickly and evenly throughout the oven cavity, avoiding flavour transfer when cooking a number of different dishes at the same time.



Upper and lower element only:

A traditional cooking method best suited for single items located in the centre of the oven. The top of the oven will always be hottest. Ideal for roast, fruit cakes, bread etc.

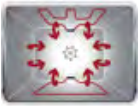

Fan with upper and lower elements:

The elements combined with the fan aim to provide more uniform heat, a similar method to conventional cooking, so pre-heat is required. Most suitable for items requiring slow cooking methods.



Circulaire:

The combination of the fan and circular element around it gives a hot air cooking method. This provides many benefits including no preheat if cook time is more than 20 minutes, no flavour transfer when cooking different foods at the same time, less energy, and shorter cook times. Good for all types of food.



Circulaire with upper and lower elements:

The use of the fan with both elements allows food to be cooked quickly and effectively, ideal for large joints that require thorough cooking. It offers a similar result to rotisserie, moving the heat around the food, instead of moving the food itself, enabling any size or shape to be cooked.

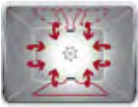

ECO:

The combination of the grill, fan (if present) and lower element is particularly suitable for cooking small quantities of food.

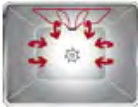

Fan with grill element:

The fan reduces the fierce heat from the grill, providing an excellent method of grilling various foods, chops, steaks, sausages etc. giving even browning and heat distribution, without drying out the food. The top two levels recommended for use, and the lower part of the oven can be used to keep items warm at the same time, an excellent facility when cooking a grilled breakfast. Half grill (centre portion only) is ideal for small quantities of food.



Grill element:

For rapid cooking and browning of foods. Best results can be obtained by using the top shelf for small items, the lower shelves for larger ones, such as chops or sausages. For half grill heat is generated only at the centre of the element, so is ideal for smaller quantities.

Auxiliary Oven



FAN WITH LOWER ELEMENT/ CIRCOGAS:

In electric ovens this combination completes cooking more quickly of foods that are ready on the surface, but that require more cooking inside, without further browning. In gas ovens the fan distributes the heat quickly and evenly throughout the oven cavity, avoiding flavour transfer when cooking a number of different dishes at the same time.

**Circulaire with lower element :**

The addition of the lower element adds extra heat at the base for food which requires extra cooking..

**Upper and lower element only:**

A traditional cooking method best suited for single items located in the centre of the oven. The top of the oven will always be hottest. Ideal for roast, fruit cakes, bread etc.

**Fan with upper and lower elements:**

The elements combined with the fan aim to provide more uniform heat, a similar method to conventional cooking, so pre-heat is required. Most suitable for items requiring slow cooking methods.

**Circulaire:**

The combination of the fan and circular element around it gives a hot air cooking method. This provides many benefits including no preheat if cook time is more than 20 minutes, no flavour transfer when cooking different foods at the same time, less energy, and shorter cook times. Good for all types of food.

**Fan with grill element:**

The fan reduces the fierce heat from the grill, providing an excellent method of grilling various foods, chops, steaks, sausages etc. giving even browning and heat distribution, without drying out the food. The top two levels recommended for use, and the lower part of the oven can be used to keep items warm at the same time, an excellent facility when cooking a grilled breakfast. Half grill (centre portion only) is ideal for small quantities of food.

**Grill element:**

For rapid cooking and browning of foods. Best results can be obtained by using the top shelf for small items, the lower shelves for larger ones, such as chops or sausages. For half grill heat is generated only at the centre of the element, so is ideal for smaller quantities.

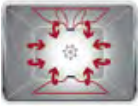
**Pizza function:**

The simultaneous operation of these three elements ensures an optimum cooking facility, ideal not only for pizza but also for cookies, quiches and flans.



A5-81

Opera range
150 cm
stainless steel
hob type: gas + griddle
oven type: electric
energy rating AA

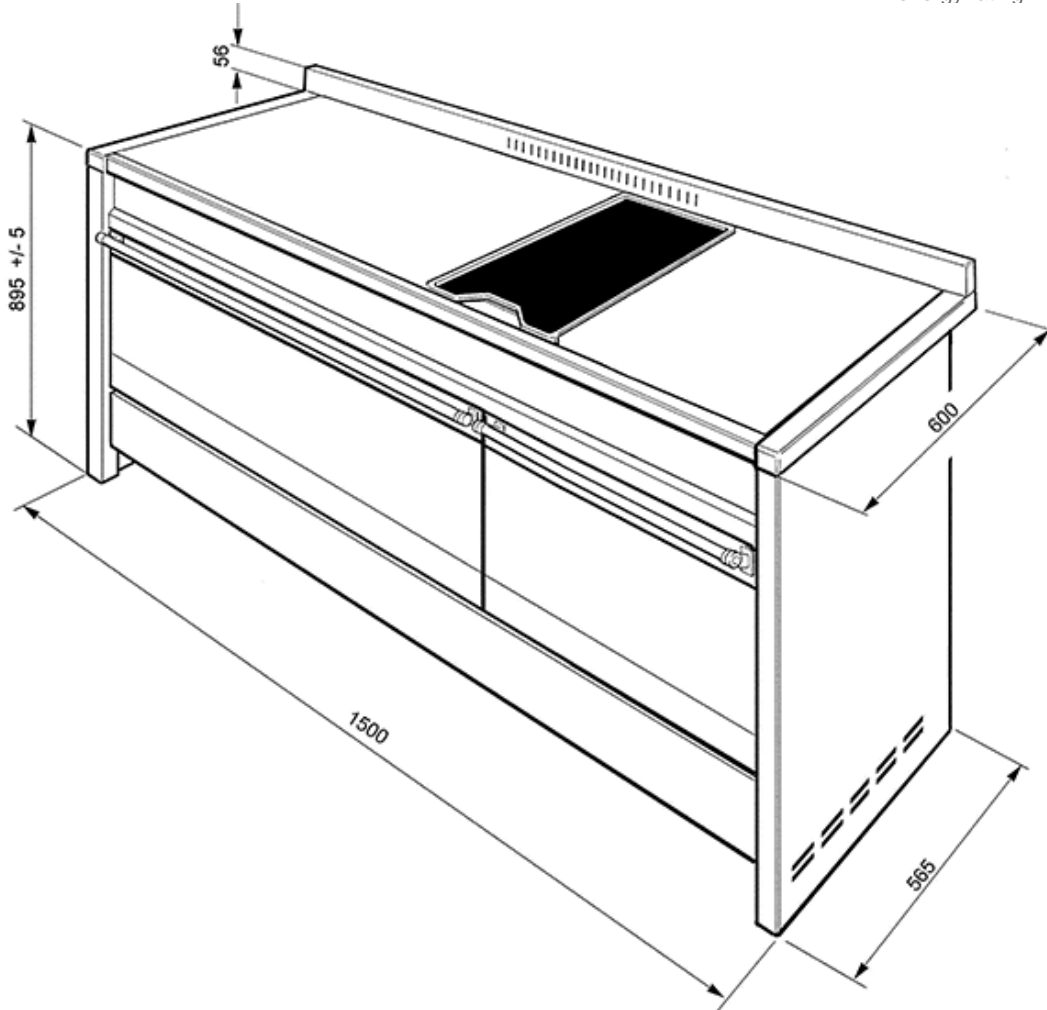

Smeg (UK) Ltd
The Magna Building, Wyndyke Furlong, Abingdon
OX14 1DZ
Tel. +44 (0)844 557 9907
Fax +44 (0)844 557 9337