

System C shelf dividing system

Combination of self adhesive ribbed foil and standard partition

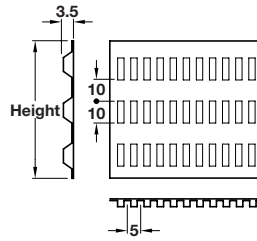
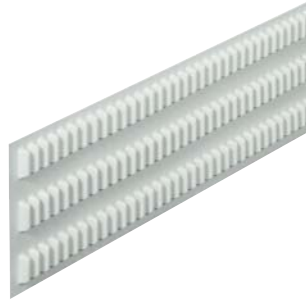
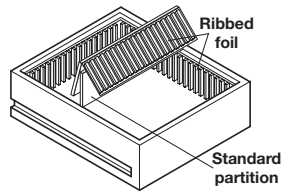

A Ribbed foil

- Self adhesive
- Length: 535 mm
- White plastic

Height	Cat. No.
40 mm	700.24.789
60 mm	700.24.725
80 mm	700.24.734
120 mm	700.24.752

Order qty: 1 pc

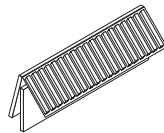

The 120 mm foil can, if bent at the middle, be used on both sides for a partition 60 mm high

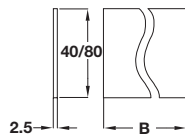

B Standard partition

- For inserting between partition holder, ribbed foil and 2.5 mm wide wooden grooves
- **Note:** If the standard partition is being used in Ratio-Pharm system **D**, its side edges must be machined to a thickness of 1.5 mm. The partition has a hole in the middle from a height of 80 mm and a width of 171 mm
- Transparent plastic

Height	Dim B	Cat. No.
40 mm	180 m	700.33.000
80 mm	310 mm	700.34.007

Order qty: 1 pc

System D shelf dividing system

Combination of grooved strips, retaining rails and partitions

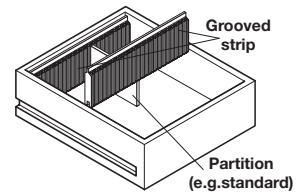

C Single grooved strip

- Glue fixing
- Length: 497 mm
- Grey plastic

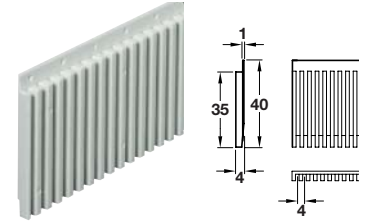

Cat. No.
Grooved strip

700.27.502

Order qty: 1 pc

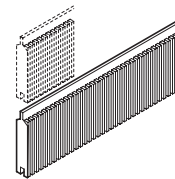

The double grooved strips can be attached together to obtain longitudinal and cross partitions of any height that is divisible by 35 mm

D Double grooved strip

- Glue fixing
- Length: 497 mm
- Grey plastic

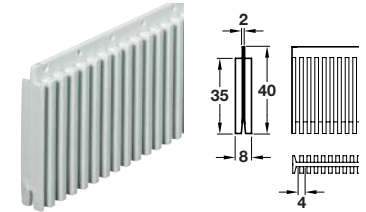

Cat. No.
Grooved strip

700.27.511

Order qty: 1 pc

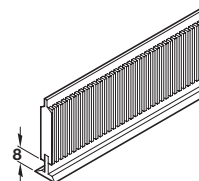

The double groove strip is mounted to the T-profile for added stability. The overall height is then increased by 8 mm

E Aluminium T-profile

- Length: 492 mm
- For reinforcing the double grooved strip
- Bright aluminium



Cat. No.
Aluminium T-profile

700.27.002

Order qty: 1 pc

F Retaining rail

- Glue fixing
- Length: 498 mm
- For insertion of double grooved strip
- Alternatively partitions of 8 mm plywood can be inserted in the retaining rails
- Grey plastic

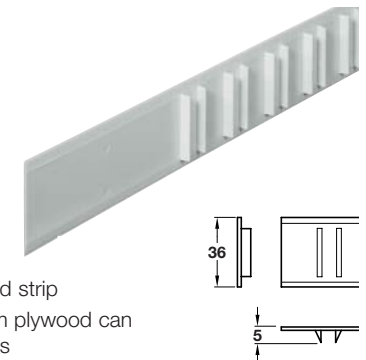

Cat. No.
Retaining rail

700.27.520

Order qty: 1 pc