

TWIN BALL CATCHES

Solid brass catches for heavy duty applications.

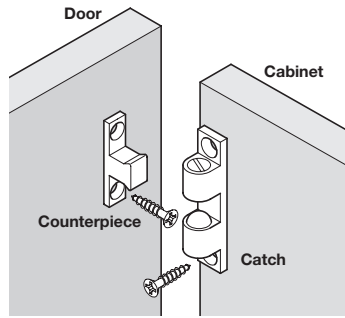

Twin ball catch, 43 mm

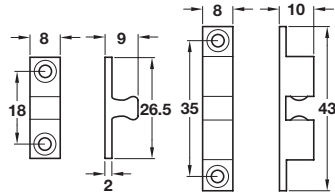
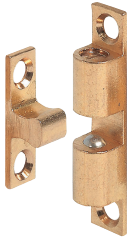

- > Retaining pressure is adjustable with a screw driver
- > Bright brass catch and counterpiece
- > Solid chrome steel balls
- > Order qty: 1 pc



Finish	Cat. No.
Brass	244.20.014

Twin ball catch, 49 mm

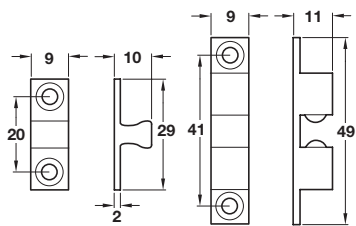
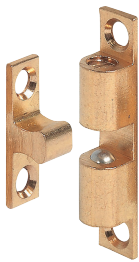

- > Retaining pressure is adjustable with a screw driver
- > Bright brass catch and counterpiece
- > Solid chrome steel balls
- > Order qty: 1 pc



Finish	Cat. No.
Brass	244.20.015

Twin ball catch, 60 mm

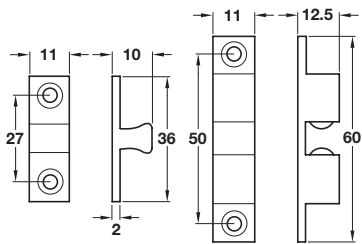
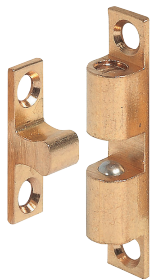

- > Retaining pressure is adjustable with a screw driver
- > Bright brass catch and counterpiece
- > Solid chrome steel balls
- > Order qty: 1 pc



Finish	Cat. No.
Brass	244.20.016

Twin ball catch, 70 mm

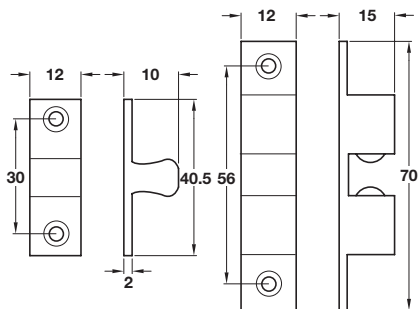

- > Retaining pressure is adjustable with a screw driver
- > Bright brass catch and counterpiece
- > Solid chrome steel balls
- > Order qty: 1 pc



Finish	Cat. No.
Brass	244.20.017