

FINGERFIX SLIDING DOOR SYSTEM

Straight sliding top hung cupboard door gear for domestic or light duty commercial furniture. Choice of Vorfront (overlay) or Infront (inset) running gear.

- > Fingerfix
- > Range:
 - Max. door panel weight **12 kg**
 - Min. door thickness **16 mm**
- > Running gear has ± 1.5 mm height adjustment
- > Note: Housing must be unscrewed to remove door

Vorfront

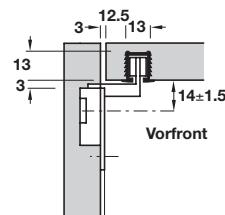

Infront

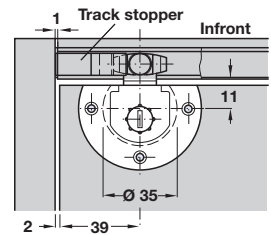
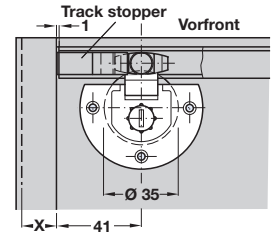
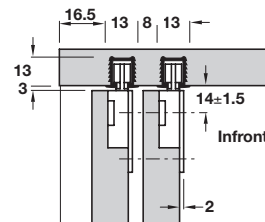

Finger Fix Vorfront and Infront tracks

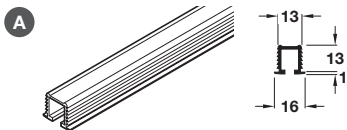

A Top track, ribbed, press-fit installation, silver coloured plastic
 > Order qty: 1 pc (2.0 m length)

Item	Cat. No.
A Top track	404.71.902

Finger Fix Vorfront and Infront fittings

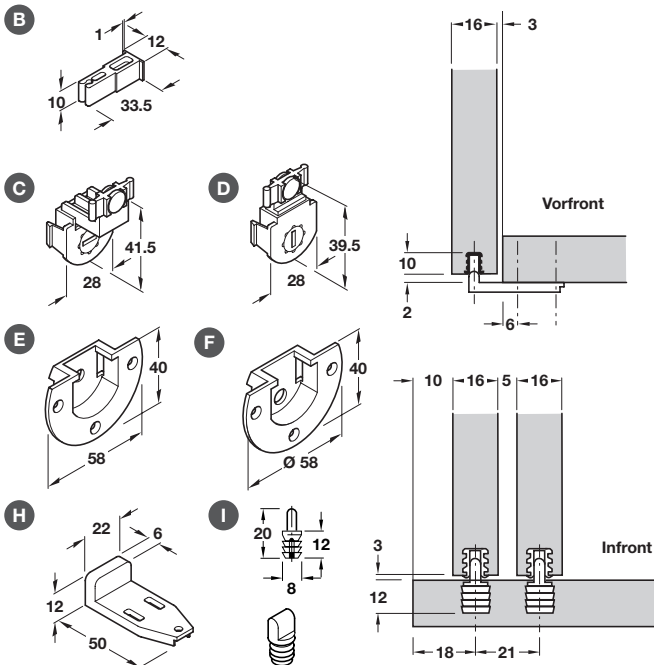

> Fitting set consists of:
 B Track stopper, with retaining spring, for top track, plastic
 C Running gear, **Vorfront** with clip, for quick mounting, black plastic
 or D Running gear, **Infront** with clip, for quick mounting, black plastic
 E Housing, screw fixing for **Vorfront** running gear, black plastic
 or F Housing, screw fixing for **Infront** running gear, black plastic
 H Bottom guide, **Vorfront** screw fixing, adjustable, black plastic
 or I Bottom guide, **Infront** plug-fit in cabinet floor, natural coloured nylon

Item	Order qty. per door	Cat. No.
B Track stopper	2 pcs	404.74.000
C Running gear, Vorfront	2 pcs	404.73.300
or D Running gear, Infront	2 pcs	404.73.311
E Housing, Vorfront	2 pcs	404.72.300
or F Housing, Infront	2 pcs	404.72.301
H Bottom guide, Vorfront	1 pc	404.74.310
or I Bottom guide, Infront	1 pc	400.46.400

Finger Fix Vorfront and Infront guide profile

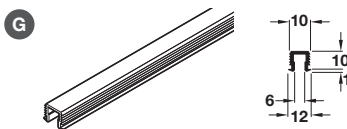

G Bottom guide profile, ribbed, press-fit installation, silver coloured plastic
 > Order qty: 1 pc (2.0 m length)

Item	Cat. No.
G Bottom guide profile	404.13.921